



Moguls at Highlands

Aspen Highlands

Feb 8, 2015 (Sun) (U0854) (U0853)

SUNDAY DUAL BRACKET

Head Judge: BUCHANAN,Stephen
Chief of Comp: ANDRINGA,Conrad J
T.D.: MATTHEWS,Craig
Chief of Scoring: GIACCO,Erin

Course: Thunderbowl

Head Judge

Chief of Scoring

T.D.

SUNDAY DUAL BRACKET

Duals Run 1 Entrants Date: Feb 7, 2015 (Sat)
Female/Male (By Duals Run-order) Time: 5:30 pm
Aspen Highlands Moguls at Highlands

Male Road to Semi-Finals (5.1B)

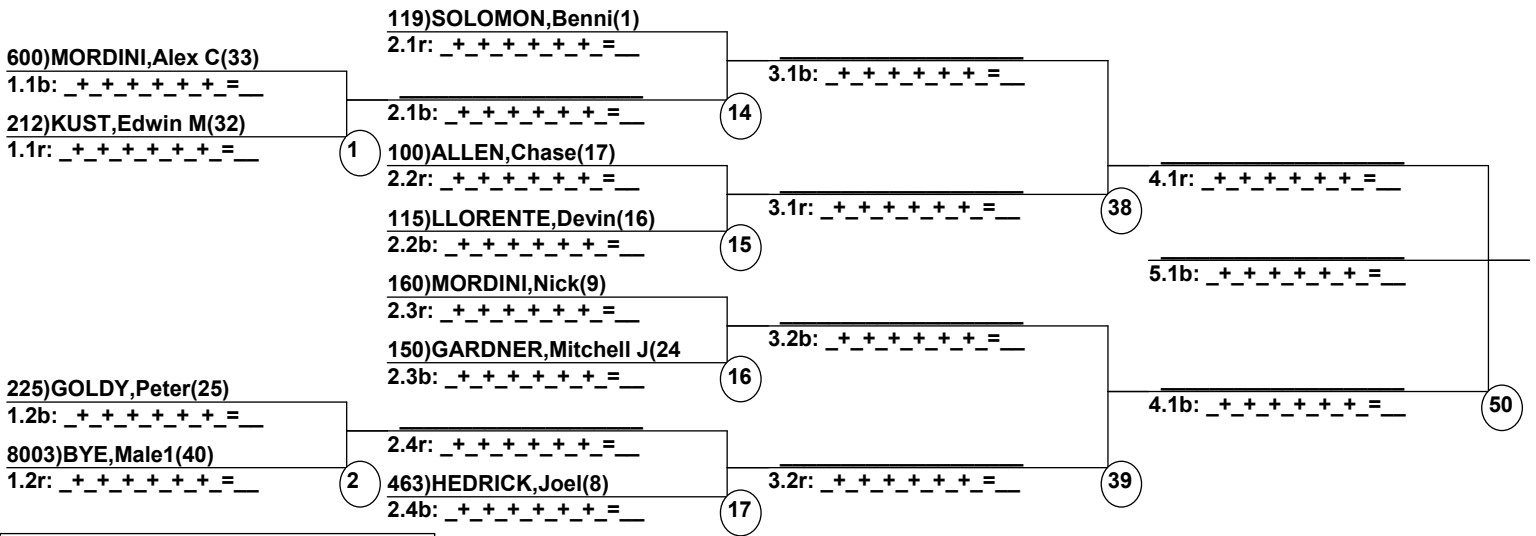

Male Road to Semi-Finals (5.1R)

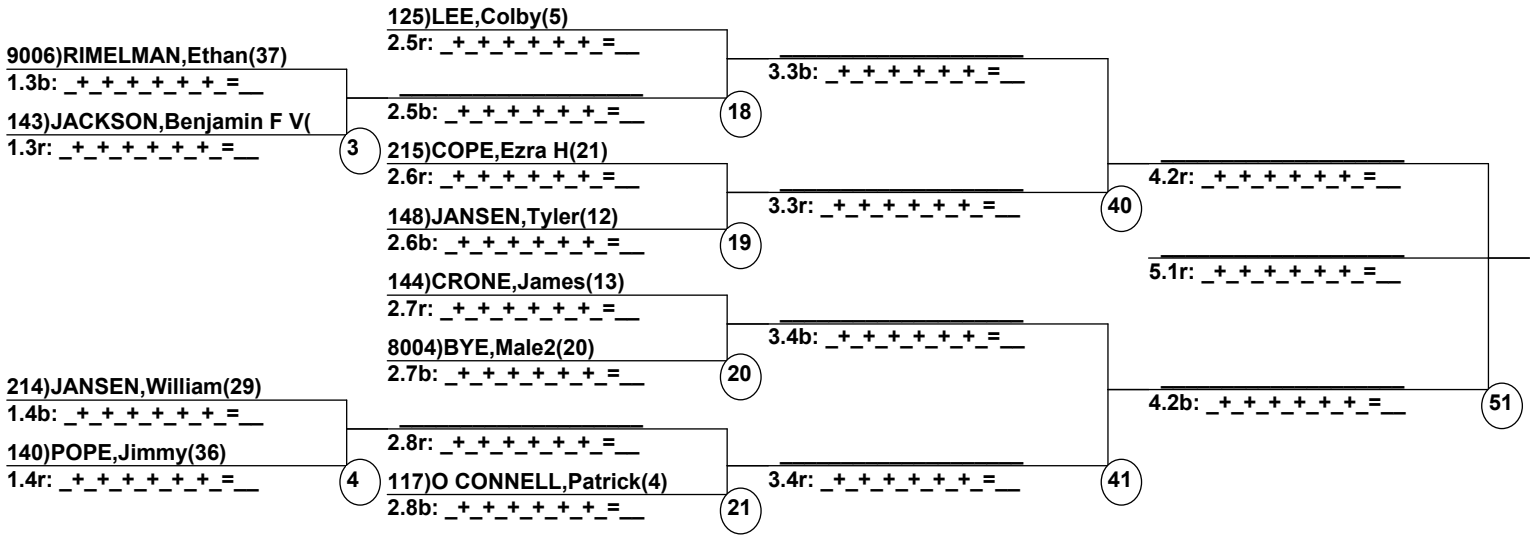

Male Road to Semi-Finals (5.2B)

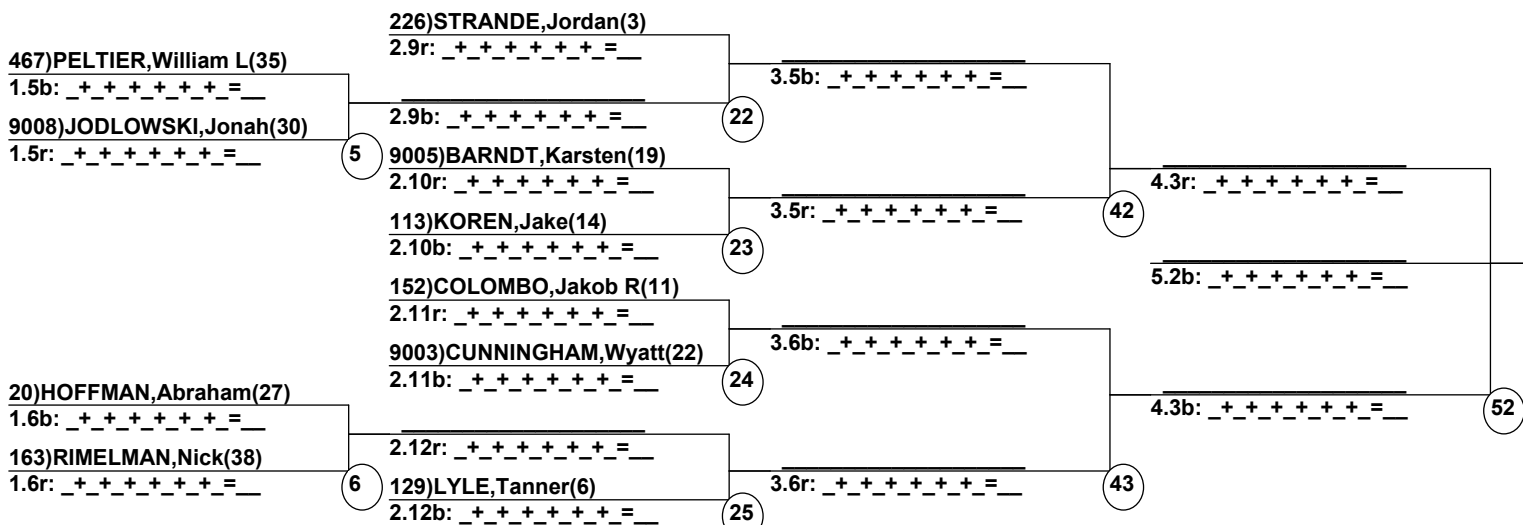

Male Road to Semi-Finals (5.2R)

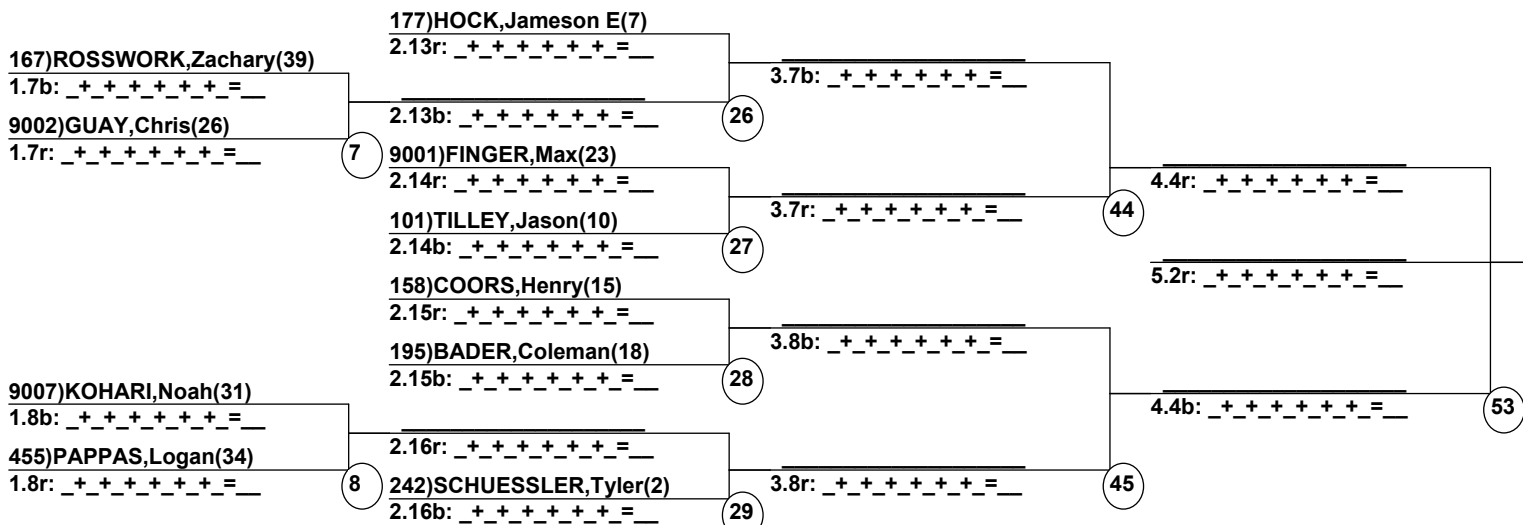

Female Road to Semi-Finals (4.1B)

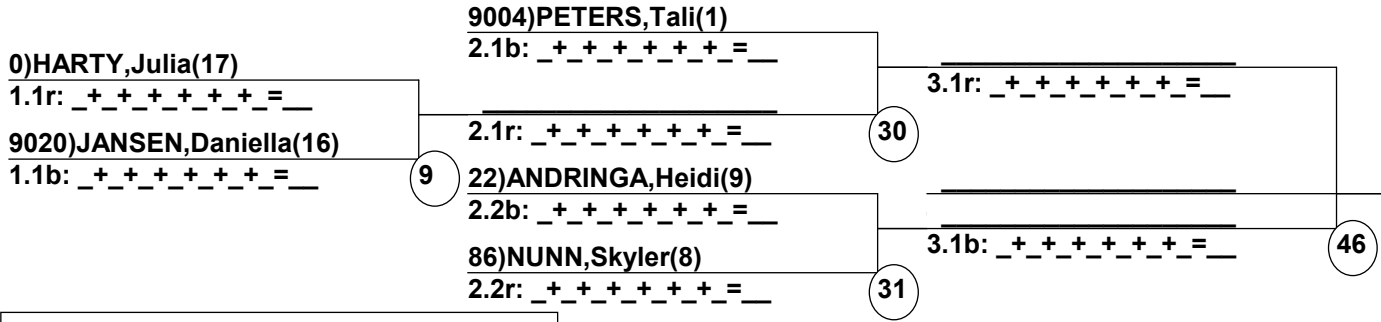

Female Road to Semi-Finals (4.1R)

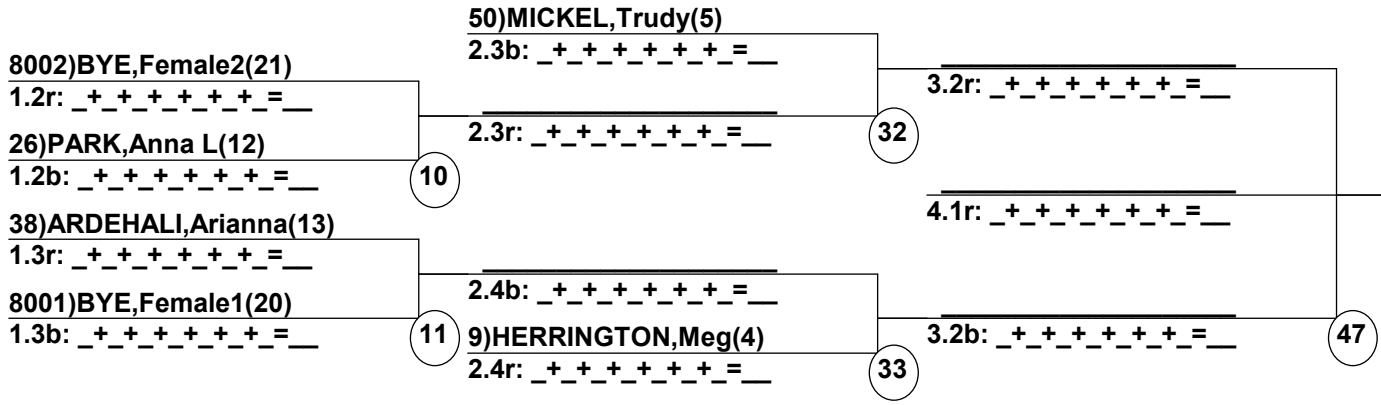

Female Road to Semi-Finals (4.2B)

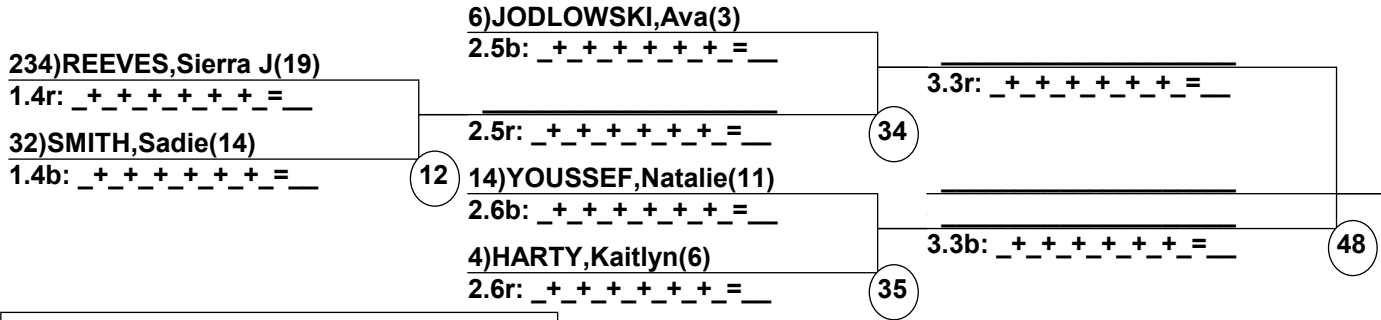

Female Road to Semi-Finals (4.2R)

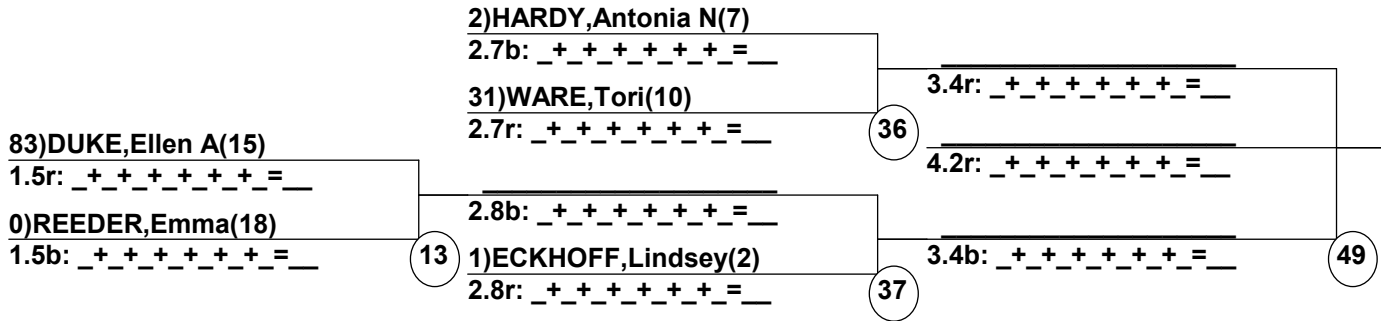

Male Semi-Finals

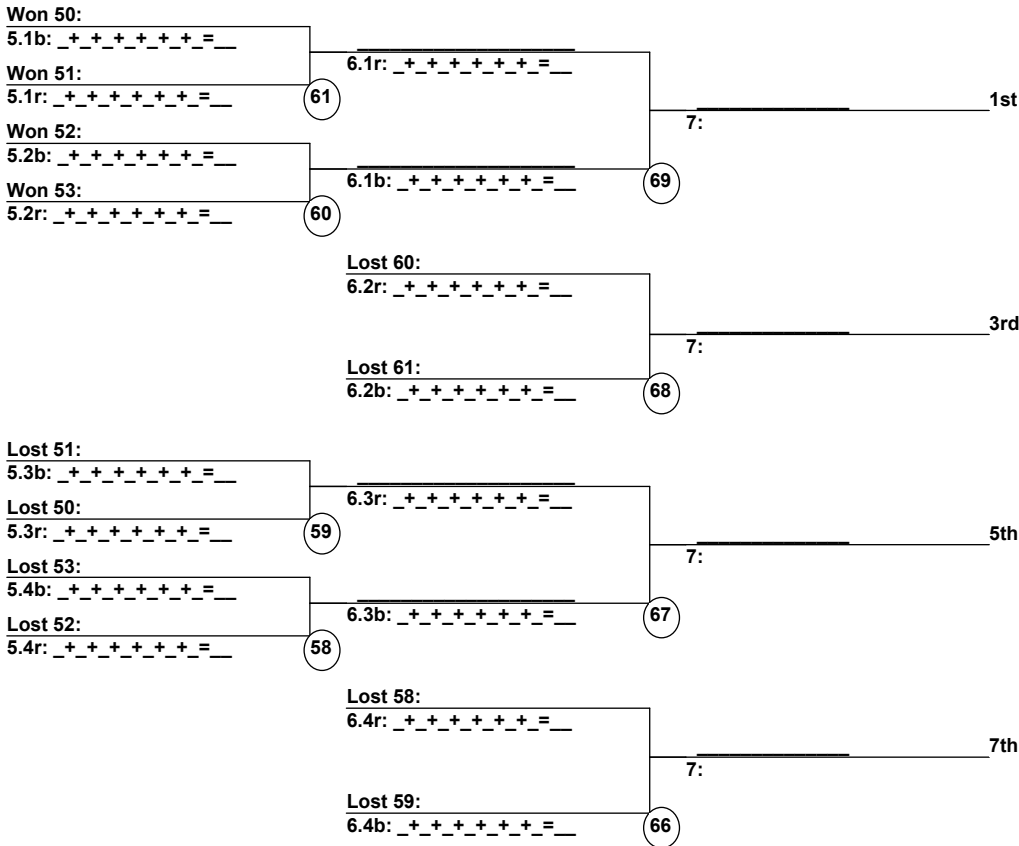

Female Semi-Finals

