



Qualifier Moguls at Winter Park

Winter Park
Feb 10, 2013 (Sun) (N0504) (N0503)

Qualifier Dual Moguls at Winter Park - February 10

Head Judge: CRONIN, Ashley
 Chief of Comp: MOONEY, Laurie
 T.D.: CAHALANE, Craig
 Chief of Scoring: BERGGREN, Sarah (6475310)
 Judge 1: CRONIN, Ashley
 Judge 2: DALY, Jeff
 Judge 3: POWELL, Helena

Course: Bradley's Bash
 Length: 150 m
 Width: 15 m
 Pitch: 22.5 deg
 _____ Head Judge
 _____ Chief of Scoring
 _____ T.D.

Qualifier Dual Moguls at Winter Park - February 10

 Duals Run 1 Entrants Date: Feb 9, 2013 (Sat)
 Female/Male (By Duals Run-order) Time: 4:13 pm
 Winter Park Qualifier Moguls at

Male Road to Semi-Finals (5.1B)

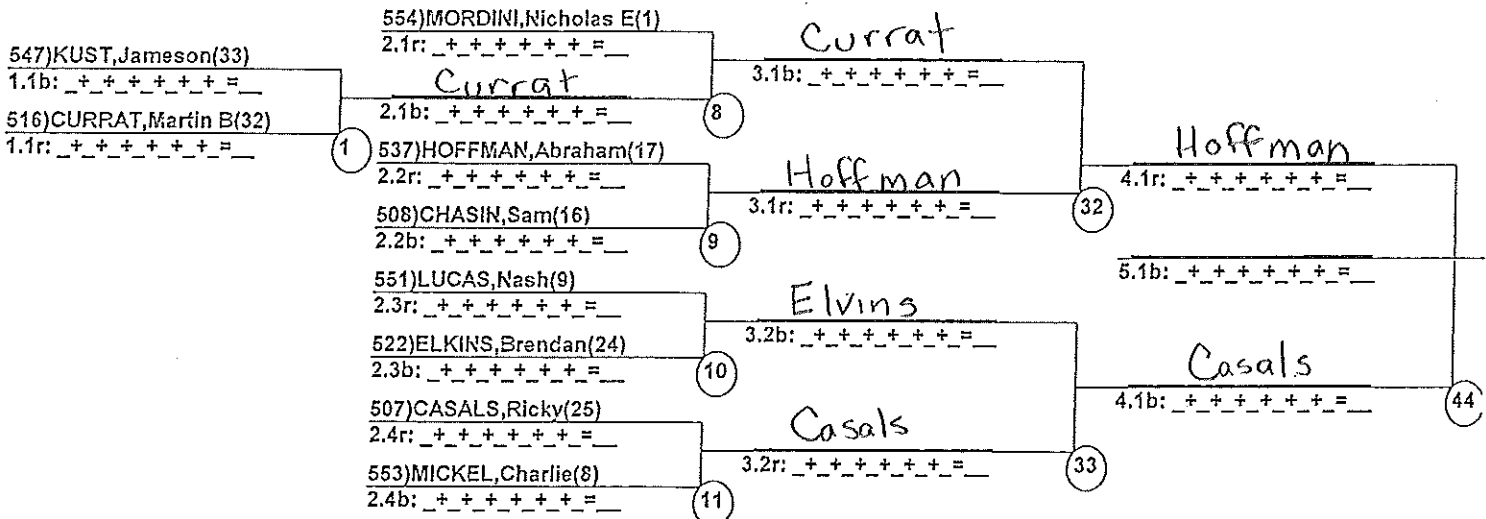

Male Road to Semi-Finals (5.1R)

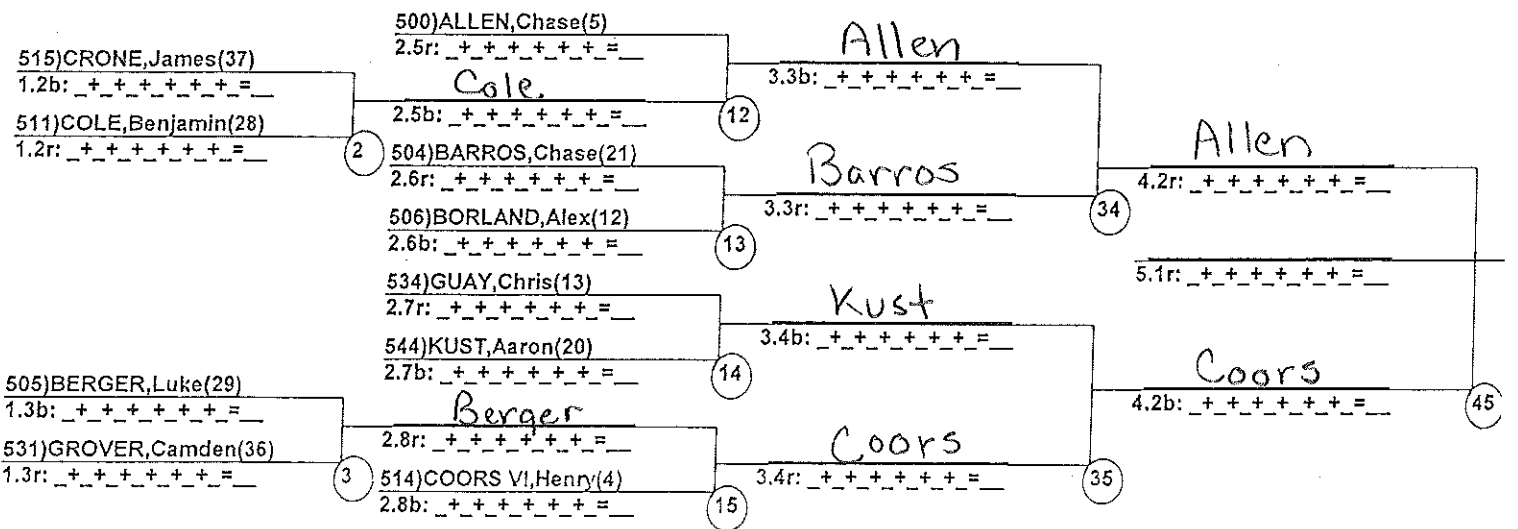

Male Road to Semi-Finals (5.2B)

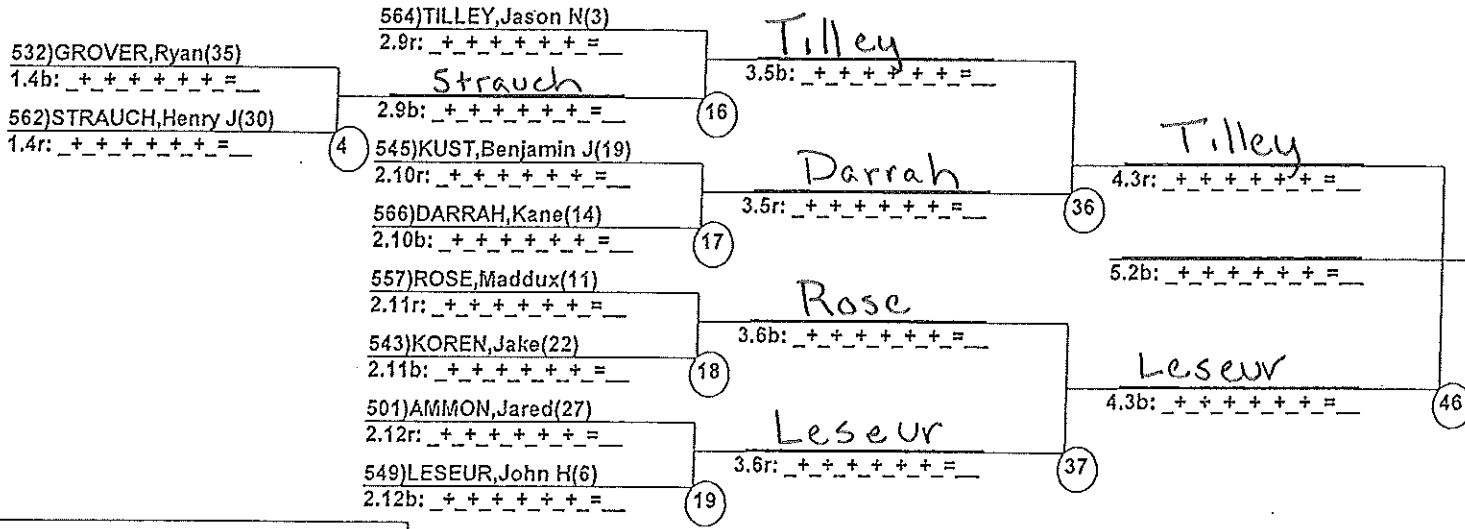

Male Road to Semi-Finals (5.2R)

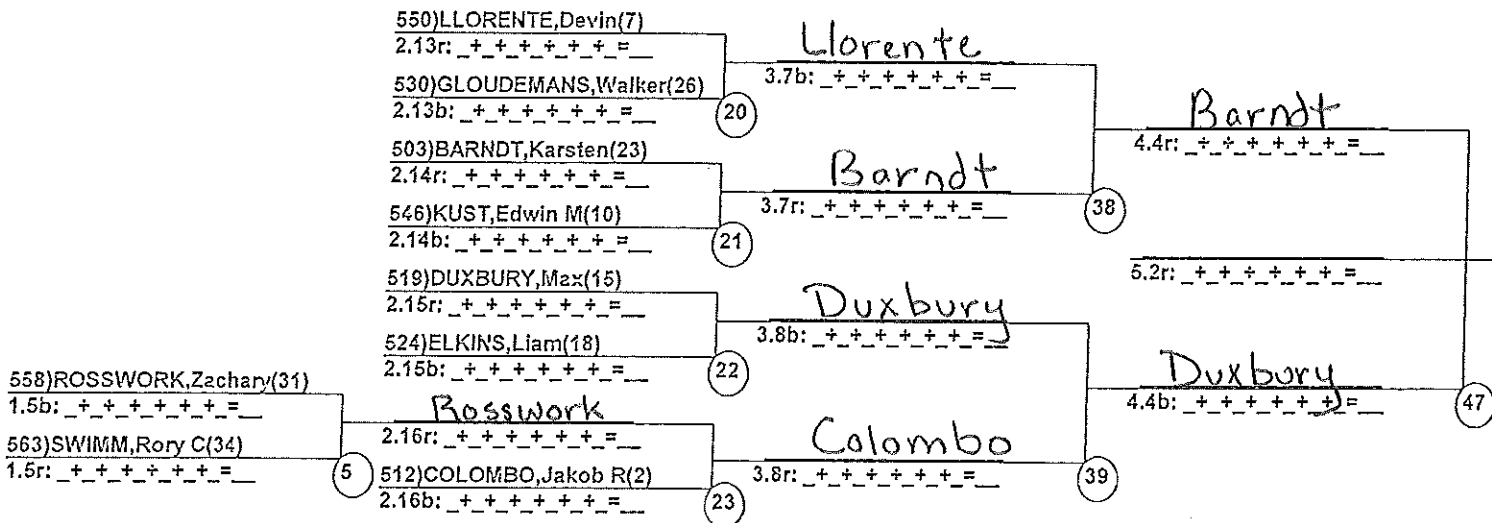

Female Road to Semi-Finals (4.1B)

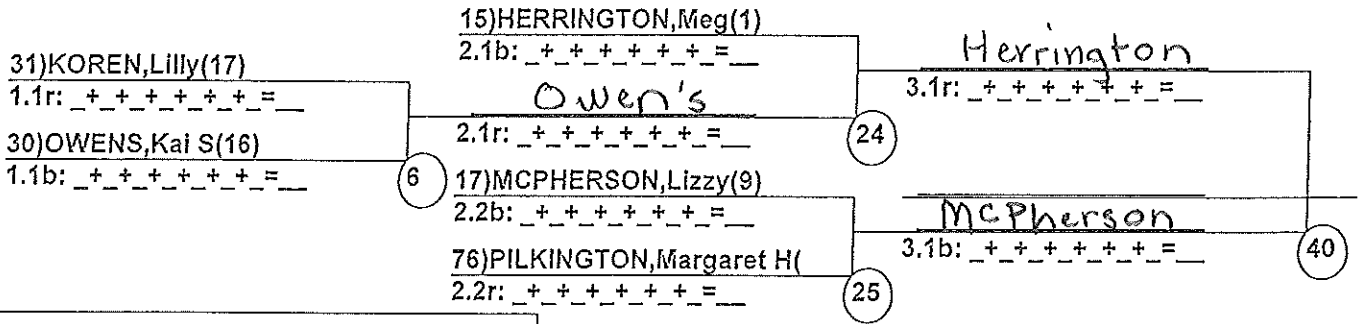

Female Road to Semi-Finals (4.1R)

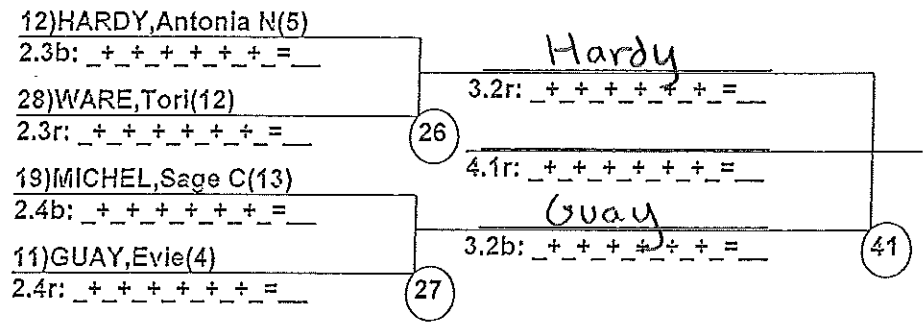

Female Road to Semi-Finals (4.2B)

24)MICKEL,Trudy(3)

2.5b: _+_+_+_+_+_=_

Mickel

5)COLE,Mellani(14)

2.5r: _+_+_+_+_+_=_

3.3r: _+_+_+_+_+_=_

28

7)COLOMBO,Jenna(11)

2.6b: _+_+_+_+_+_=_

4.2b: _+_+_+_+_+_=_

mepherson

18)MCPHERSON,Xan(6)

2.6r: _+_+_+_+_+_=_

3.3b: _+_+_+_+_+_=_

29

42

Female Road to Semi-Finals (4.2R)

27)SKIDMORE,Maggie C(7)

2.7b: _+_+_+_+_+_=_

Berger

3)BERGER,Maggie C(10)

2.7r: _+_+_+_+_+_=_

3.4r: _+_+_+_+_+_=_

30

8)CURRAT,Isabelle A(15)

1.2r: _+_+_+_+_+_=_

Currat

4.2r: _+_+_+_+_+_=_

26)SILVERSTONE,Mandy(18)

1.2b: _+_+_+_+_+_=_

2.8b: _+_+_+_+_+_=_

Berger

7

4)BERGER,Natalie J(2)

2.8r: _+_+_+_+_+_=_

3.4b: _+_+_+_+_+_=_

31

43

MaleSemi-Finals

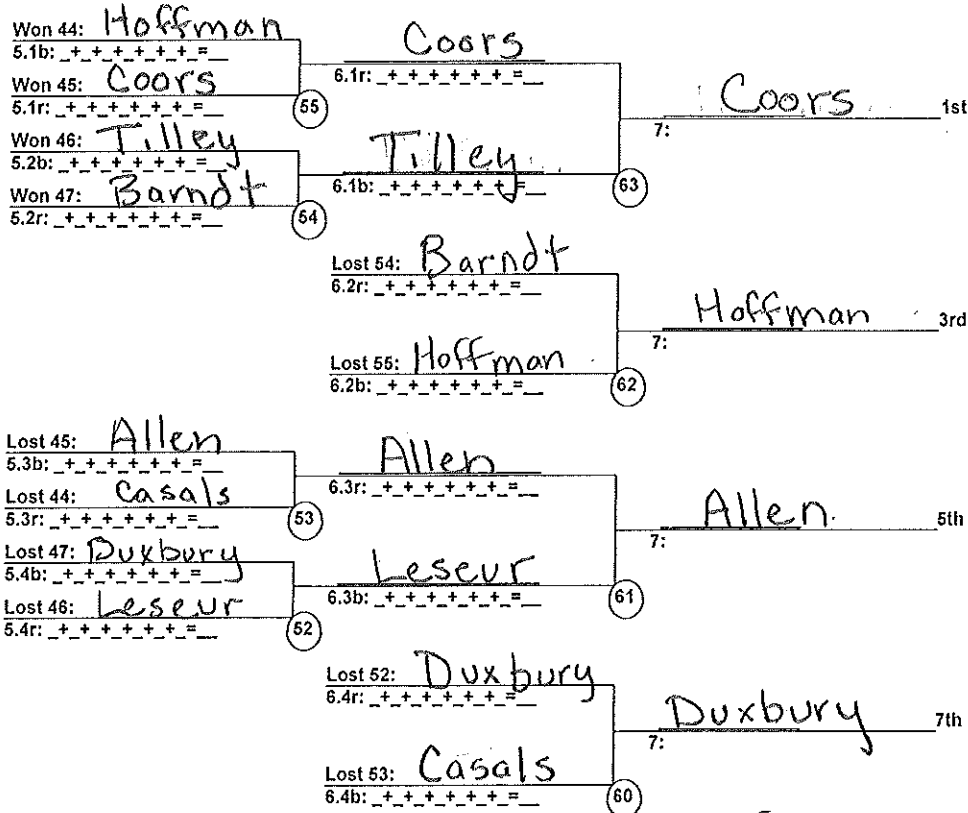

FemaleSemi-Finals

